



Automotive and Magneti Marelli FUTURE CHALLENGES

Giovanni Gaviani, Business Development VP PWT

November 2016

Magneti Marelli Company Overview



- Application Center
- ▲ R & D Center
- Production Plant

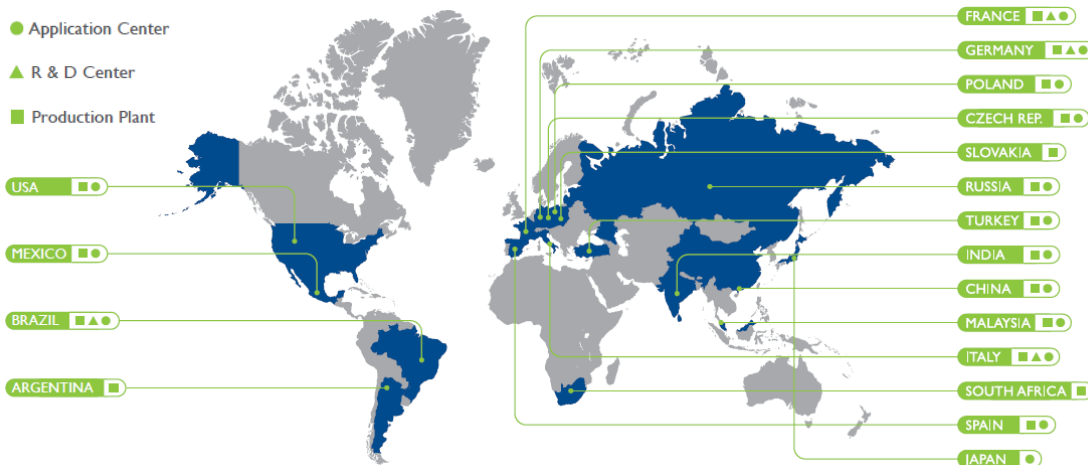

Sales 2015	7,3 bn €
R&D Centers	12
R&D (of sales)	5.8%
Production units	86
Application Centers	26
Investments (of sales)	5.2%
Employees	~ 41,900

MM Technologies for CO₂ Reduction



**MAGNETI
MARELLI**

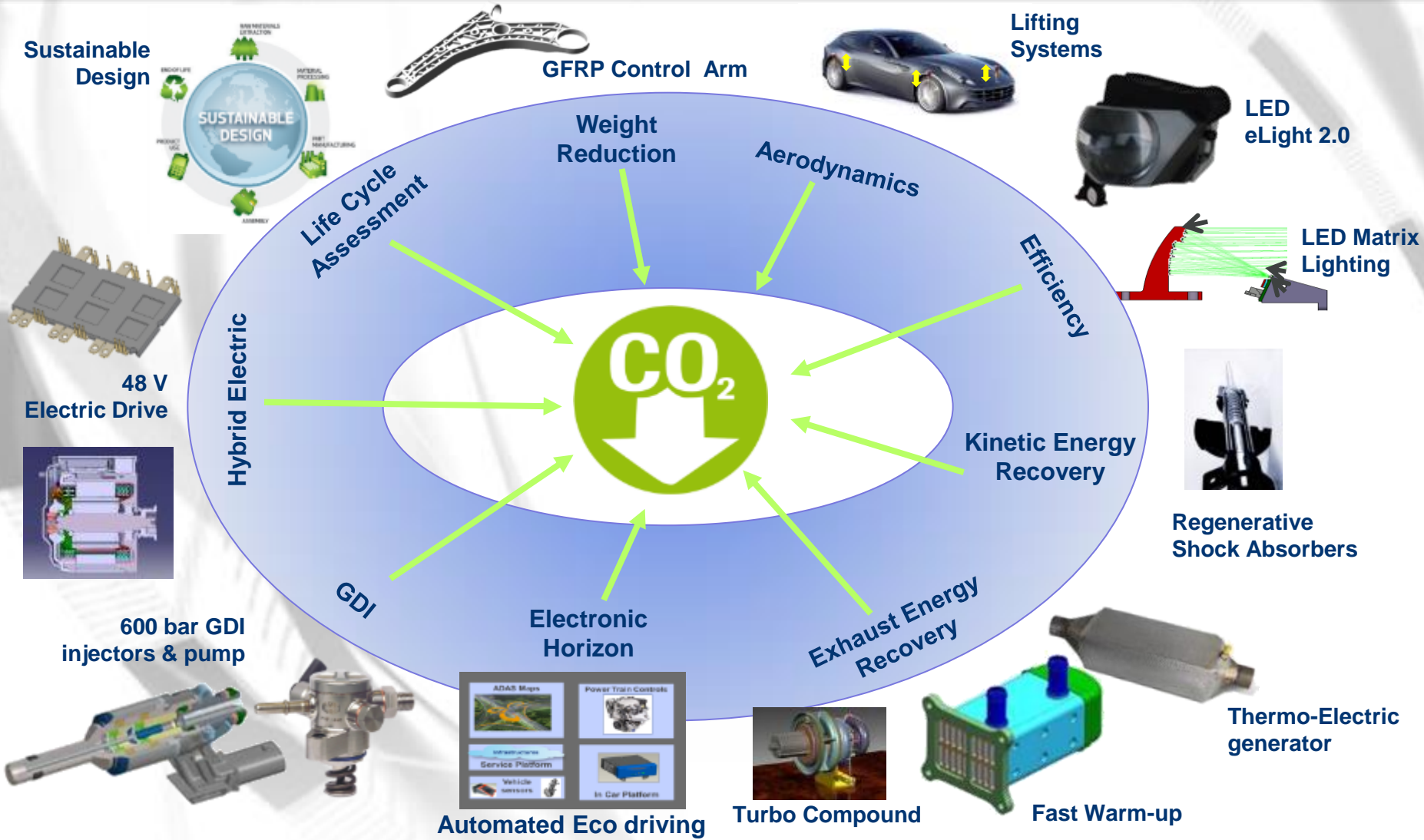



Magneti Marelli Powertrain BEV & HEV High & Low Voltage



MM : F1 K.H. transferred to Serial Application

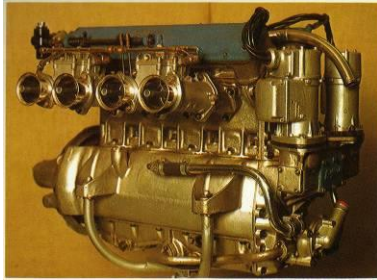

1952 → Twin Barrel Carburetor 1958

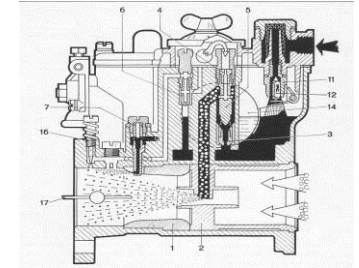

1984 → Ignition&Injection System 1985

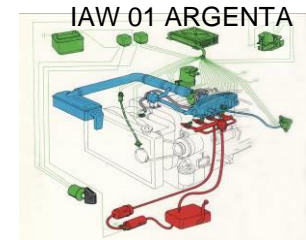

1989 → Robotized Gear Box 1997

FERRARI 355 F1



2009 → K.E.R.S. F1 2011

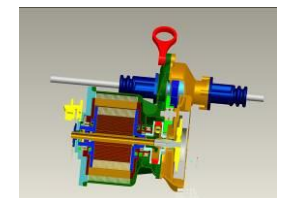

MM : New F1 K.H. transferred to Mass Production

2009-13 ...



In 2014



... in the next future



KERS

ENERGY RECOVERY SYSTEM



Kers control unit

E-Motor unit

Battery Module

CAR TELEMATIC SYSTEM



ELEC. UNITS



INJECTOR

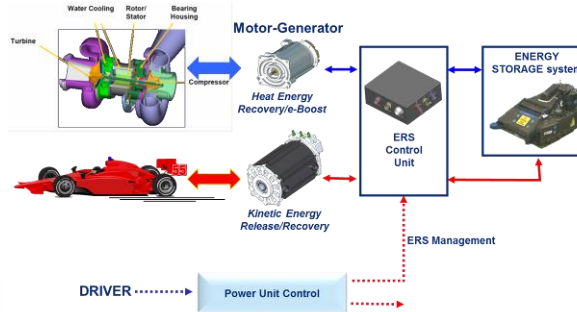

... Magneti Marelli heavily invest in Racing arena to test new challenging technologies

... performance will likely remain on par with today's cars but with a 35% fuel reduction

... we will be able to develop systems capable of delivering strong reduction in carbon dioxide emissions

from Racing experience, Technologies to mass market application

High Performance Vehicles



**MAGNETI
MARELLI**



LaFerrari

ICE 12v	800 cv
E-motor1	163 cv
E-motor2	25 cv
CO ₂	- 48%

SOP Q3 2013

**MAGNETI
MARELLI**

Future World.....



CO₂: Climate Change

“Global mean surface temperature will rise by 1.4°C to 5.8°C by the end of 2100.” - Intergovernmental Panel on Climate Change Third Report

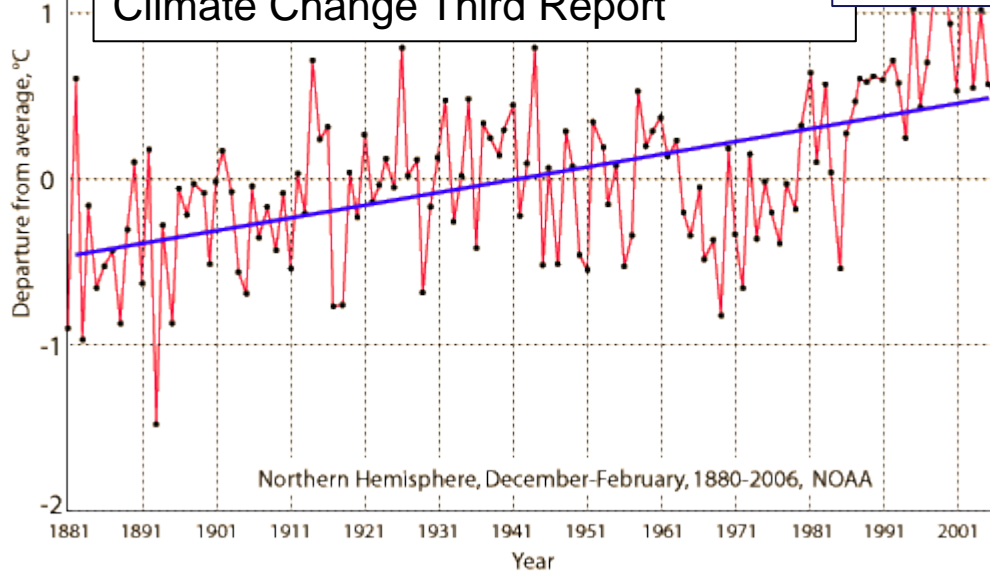

It is predicted that the Earth's average sea level will rise by 0.09 to 0.88 m between 1990 and 2100.

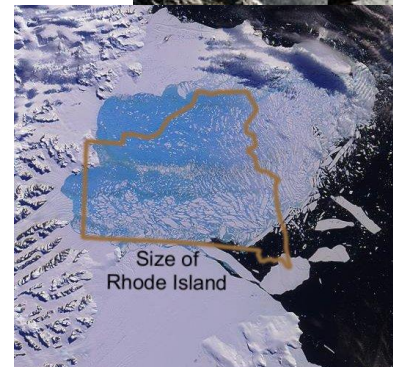
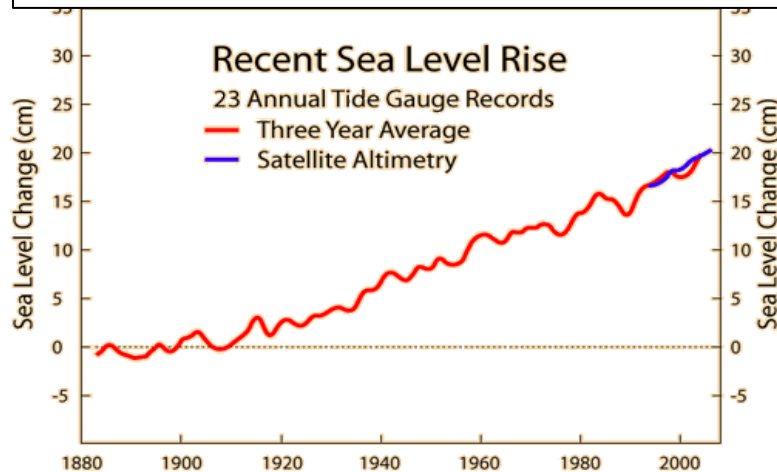

A sunny morning in Shanghai : Air Quality

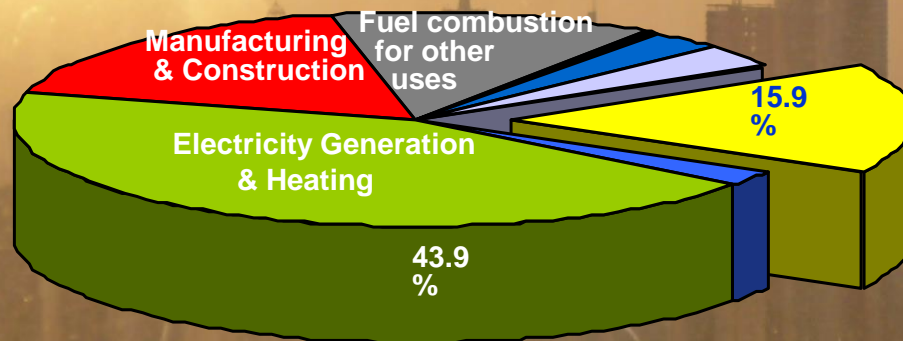

Source: EU Commission

Road Transport
(Cars, Trucks & Buses)

Following the present trend, an **80% increase in transport** emissions is expected on a worldwide scale, in 25 years.

Sustainable Mobility challenge : vision 2008

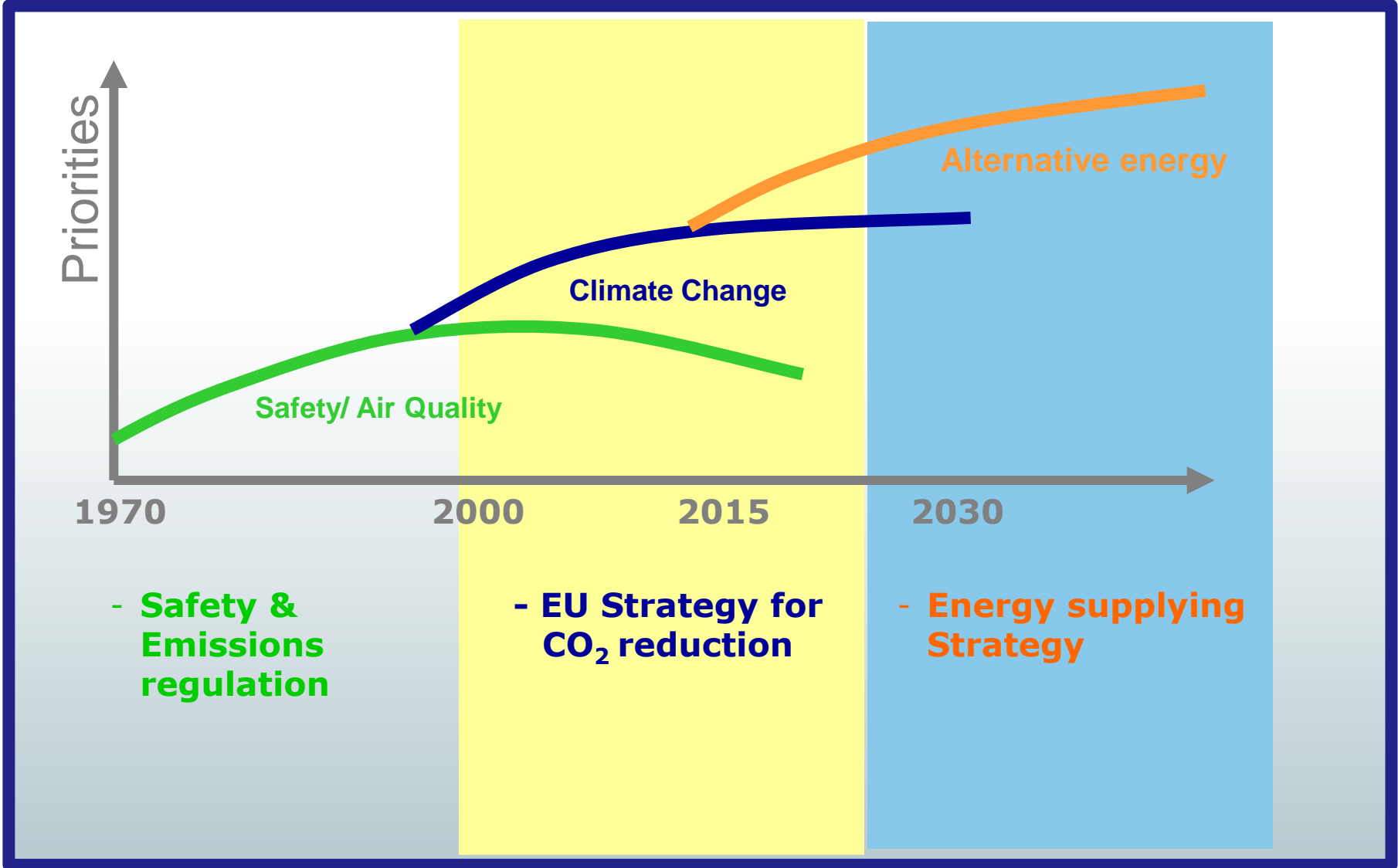

- Safety & Emissions regulation

- EU Strategy for CO₂ reduction

- Energy supplying Strategy

CO₂ and EMISSION World Wide Legislations



**MAGNETI
MARELLI**

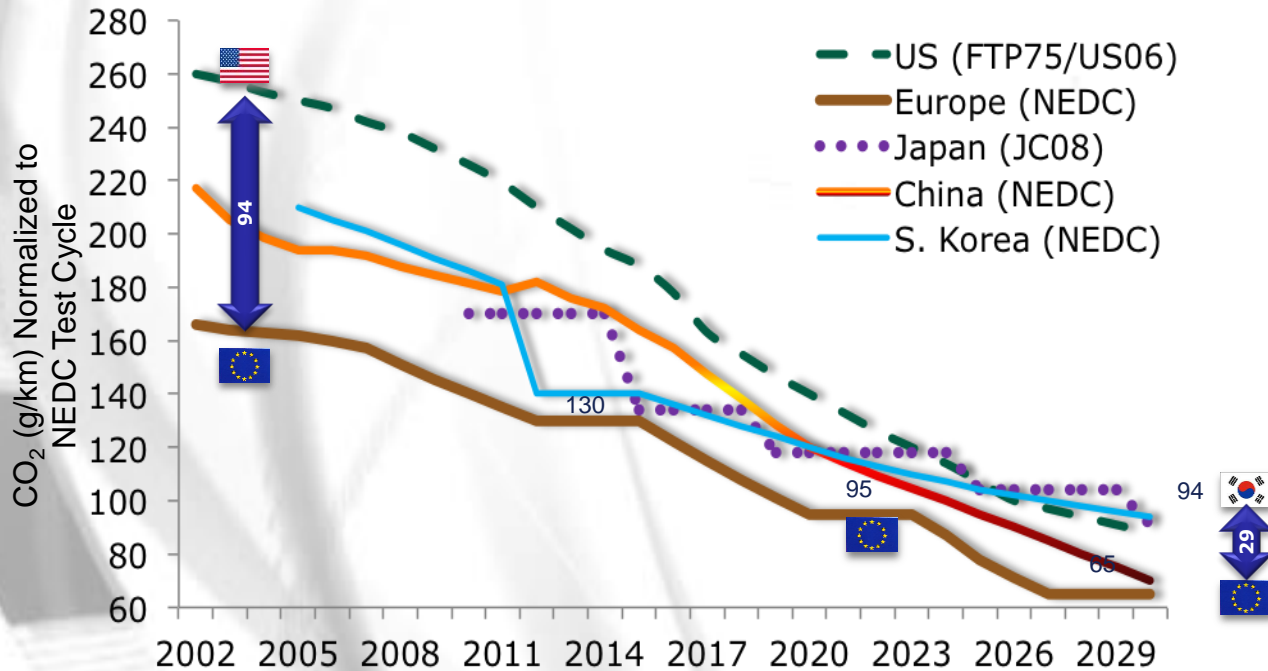

- Within **2020** will be CO₂ emission reduction vs, 2012:
 - EU = -27%
 - US = -33%
- Within **2030**, all countries will have a target CO₂ < 100 g/km

Source of data: IHS GlobalInsight

	2005	2006	2007	2008	2009	2010	2011	2012	2013	2014	2015
US	T II B8	Tier II Bin 5						Tier II Bin 4			
Europe	Euro 4				Euro 5				Euro 6		
Japan	Japan '05				Japan '09						
S. Korea	Euro 3	Euro 4				Euro 5				Euro 6	
China (Beijing)	Euro 3			Euro 4				Euro 5			

Outlook on the next ten years Technologies



Electrification

Stronger regulations on CO2 emissions, rising consumer demand, and government incentive programs for electric vehicles will boost electrical powertrain sales

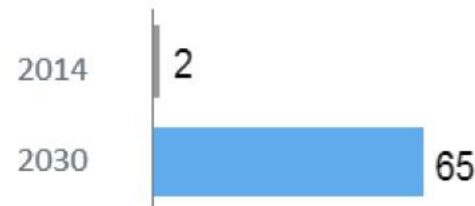

Market share of electric vehicles (incl. hybrids)
/ Percent of units produced

Source: McKinsey study for CLEPA



Automated Driving

The technological advances and growth pockets for autonomous vehicles will drive increasing levels of autonomous vehicle features, leading to new market entrants, e.g., Google, and mergers and acquisitions

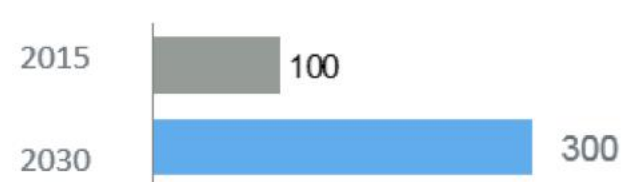

Lines of software code per vehicle
Million units

Electrification : Growing share

Vehicle sales PC incl. LCV^{et}

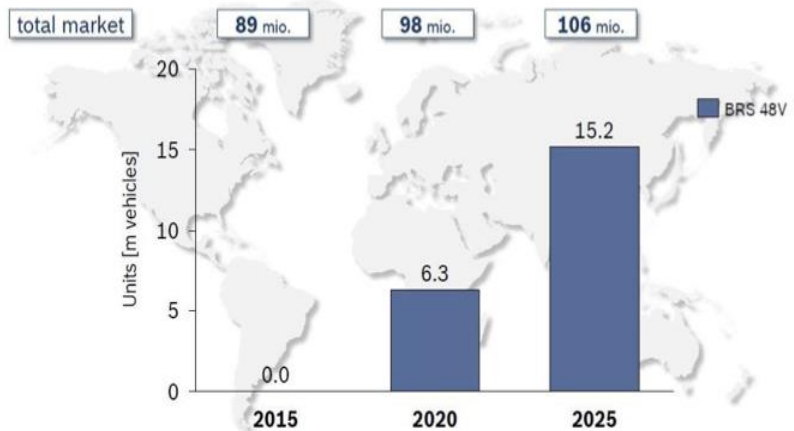

Estimation Bosch

BRS 48V – Boost Recuperation System

Vehicle sales PC incl. LCV^{et}

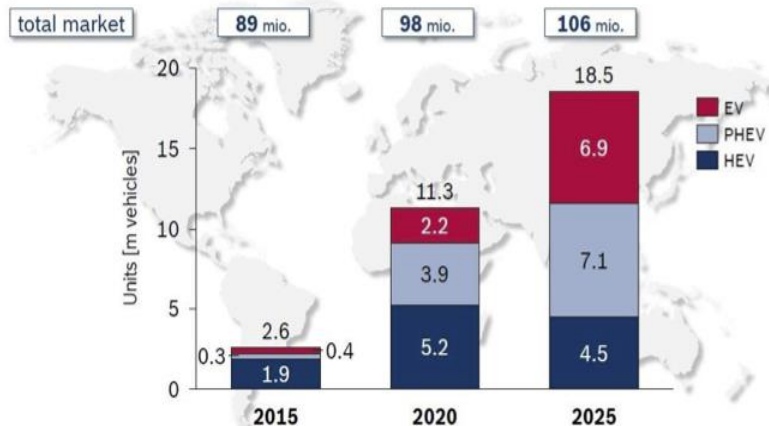

- Growing share of market
- Huge potential due to:
 - Consumers demand and political pressure for greener vehicles
 - Development of infrastructures
 - Technological progress (batteries)
 - Instability of oil price

BEVs vs ICE : Efficiency/Weight Comparison



- Electrical Vehicles give the **best efficiency** Well to Wheel 70%
- Max efficiency achievable is 25% in ICE and 35% in HEV

- Battery is key Factor for BEV success
- Mileages cannot be higher than 120 – 150 Km/recharge
- Battery (Li-ion) can achieve a cost < 200 €/kwh

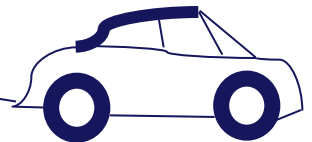
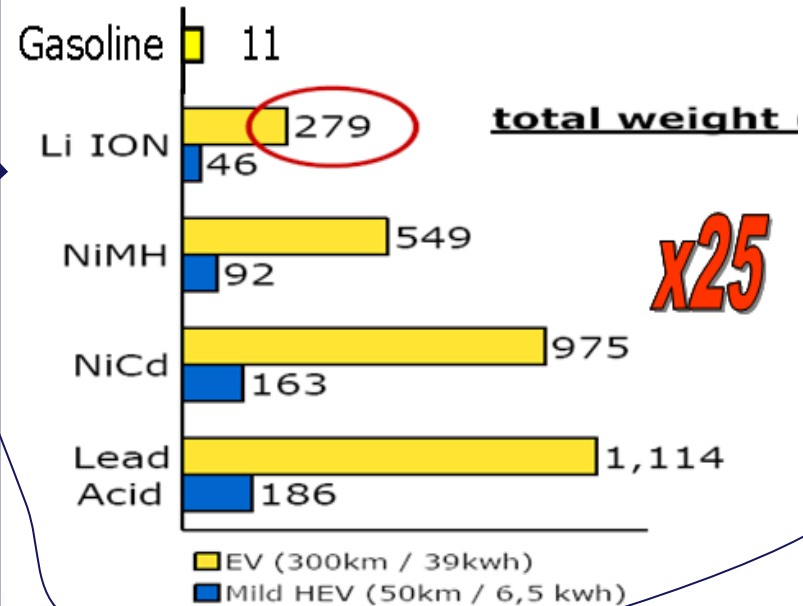
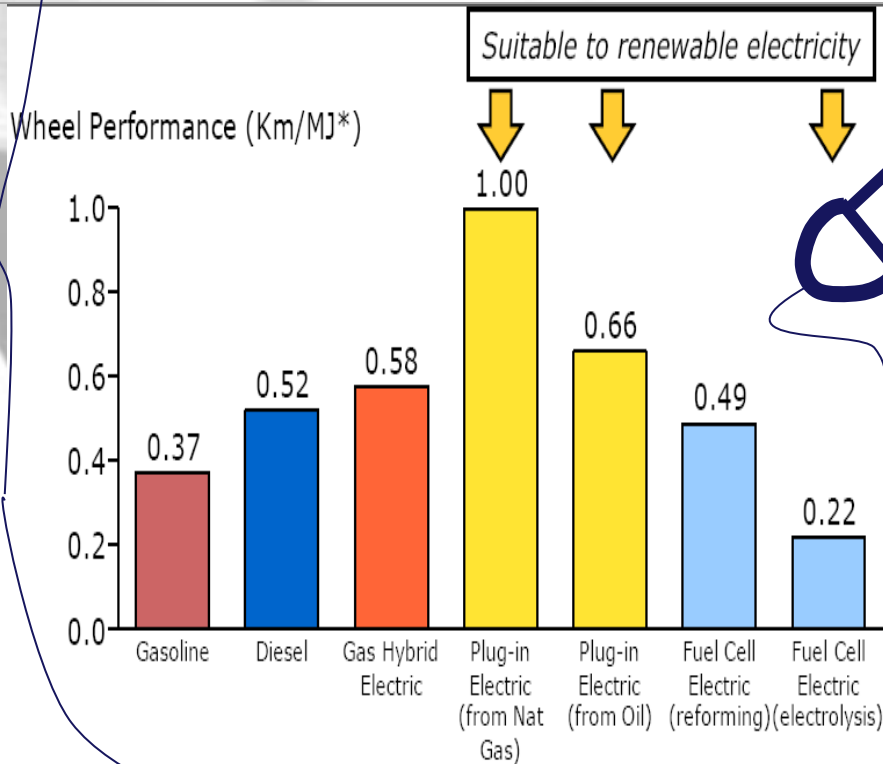

Hybrid Systems:

key element in the discontinuous technologies

In the evolution of technology hybrid systems are pretty frequent. They are where a strong **discontinuity** is fulfilled by **temporary** elements coming from both old and new technologies.

During the years of sailboats and engine boats hybrid systems had a great application in both modalities of propulsion. As sailboats did not have enough autonomy to cross the Ocean.



The evolution of hybrid systems thought us some lessons:

1. The transitional period (so called **Hybrid Kingdom**) can be long-term.

It occurred almost 90 years to navigate the Atlantic Ocean by the Savannah (first sailboat with an auxiliary engine – **1819**) and the T.W. Lawson (last pure commercial sailboat -**1907**).

2. **Initially hybrid systems** were probably **considered** to have a competitive **advantage only for specific application.**

The main reason to hybridize sailboats was to speed them in the dead zone (so called the doldrums) in the Ocean. As in those routs with trade wind sailboats remained the best solution to navigate.

From HEV and BEV to Hybrid Plug In

Stop-Start

Mild Hybrid

Full Hybrid

Plug-In Hybrid
Range Extender

BEV

Strategy



Hybrid Plug In
Low Voltage Small Car
High Voltage Bigger car



BMW 1&3

+ Kinetic Energy Recovery

+ Engine Assistance

Stop & Start

CO₂ European Passenger Car Regulation

CO₂ European Regulation in next four decades
-60% CO₂ emissions

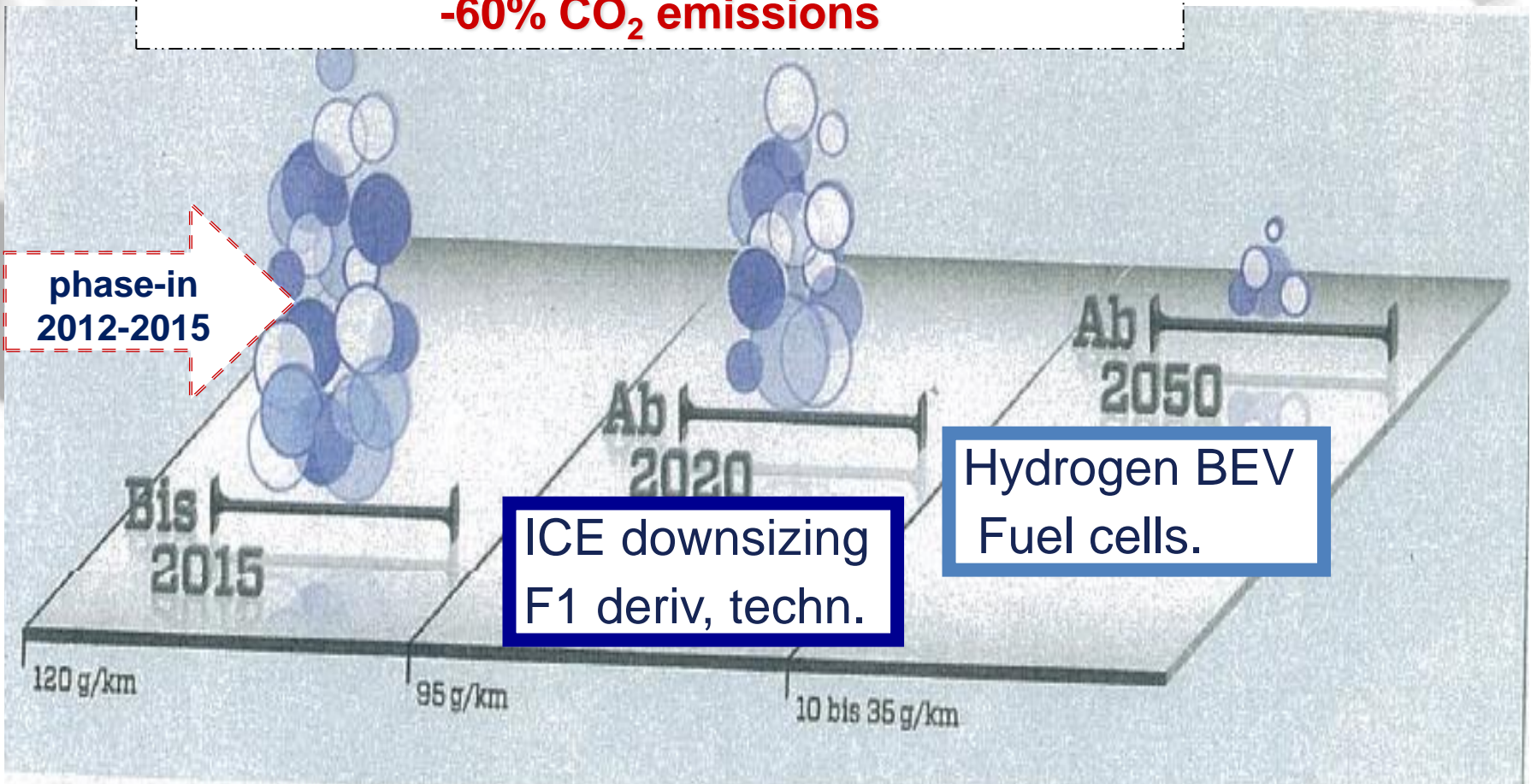

1: Global Temperature Record

Phil Jones

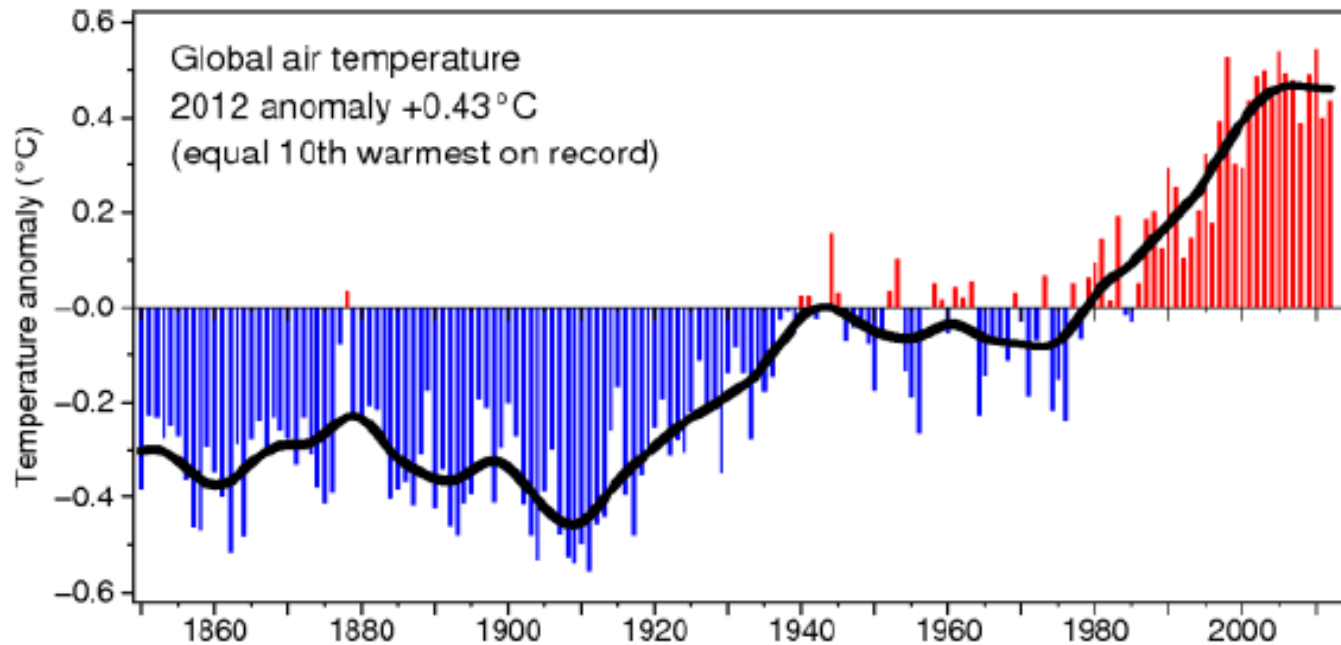

(this graph of HadCRUT4 is also available as [Encapsulated PostScript](#) and [PDF](#) suitable for publication and the data are available as [Comma-Separated Values](#))

The time series shows the combined global land and marine surface temperature record from 1850 to 2012. This year was the tenth warmest on record. This record uses the latest analysis, referred to as HadCRUT4 (Morice *et al.*, 2012).

All Starts from these analysis....**but**
When temperature is higher

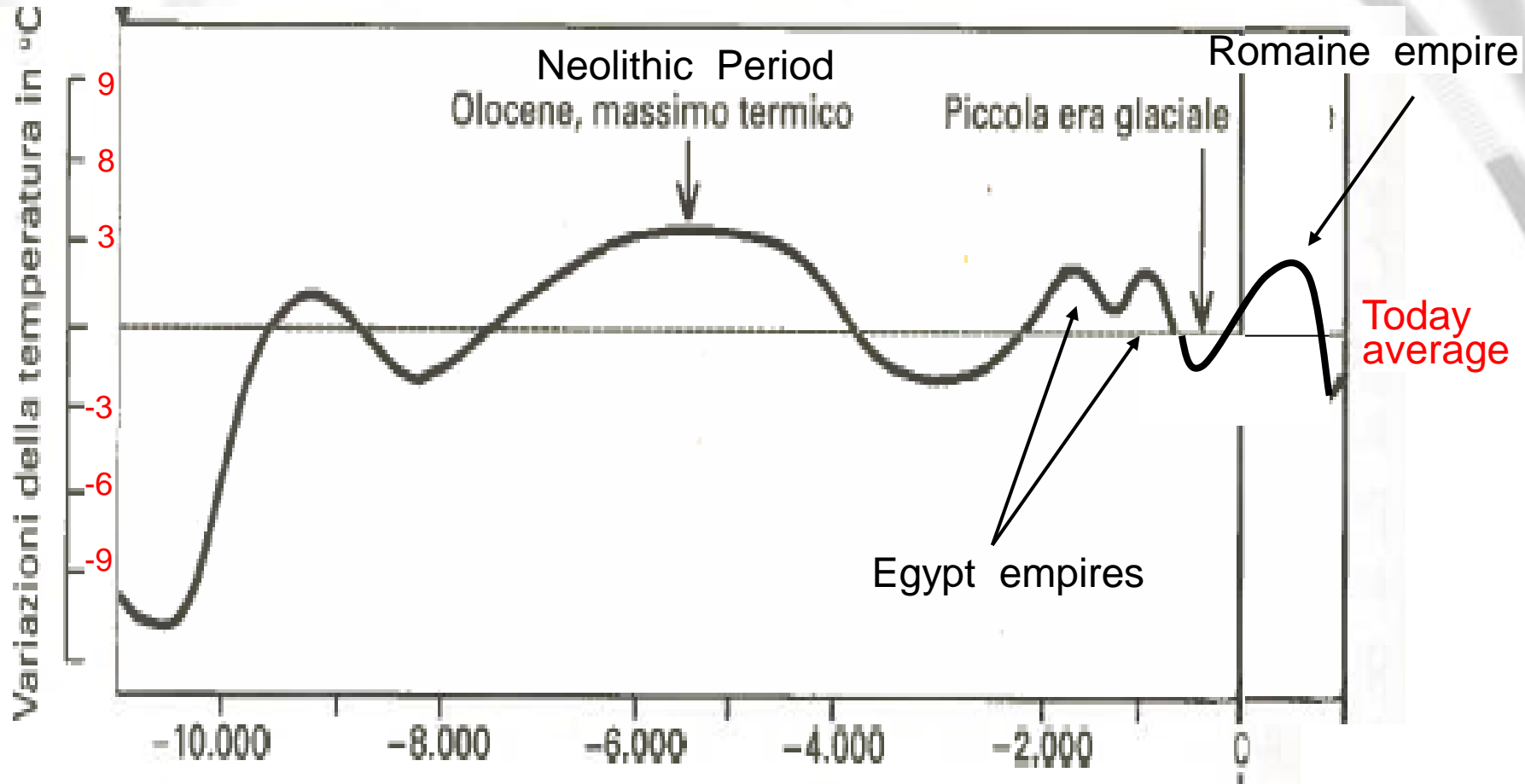

All Starts from these analysis....**but**
When temperature is higher

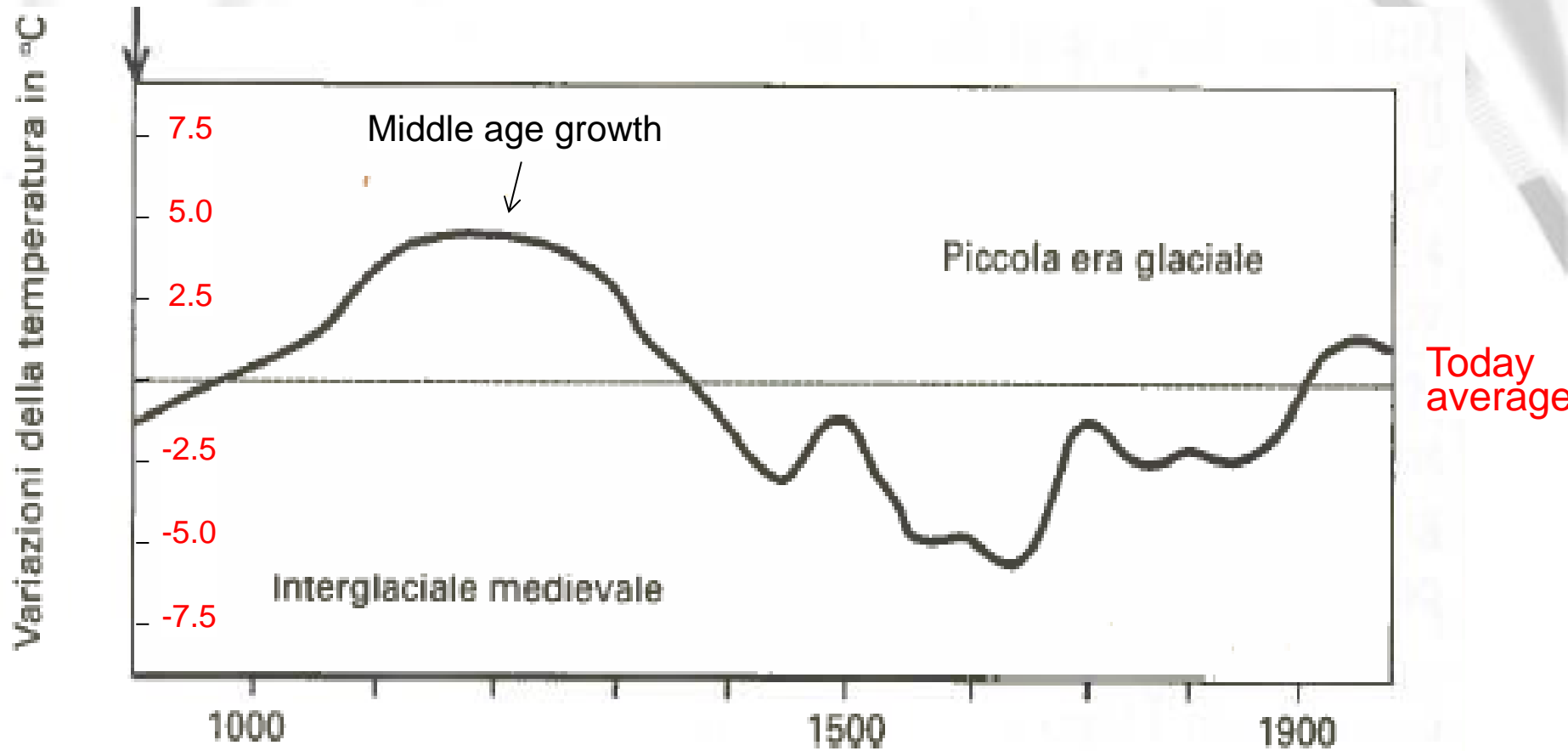

Oil WW Production and Hubbert peak

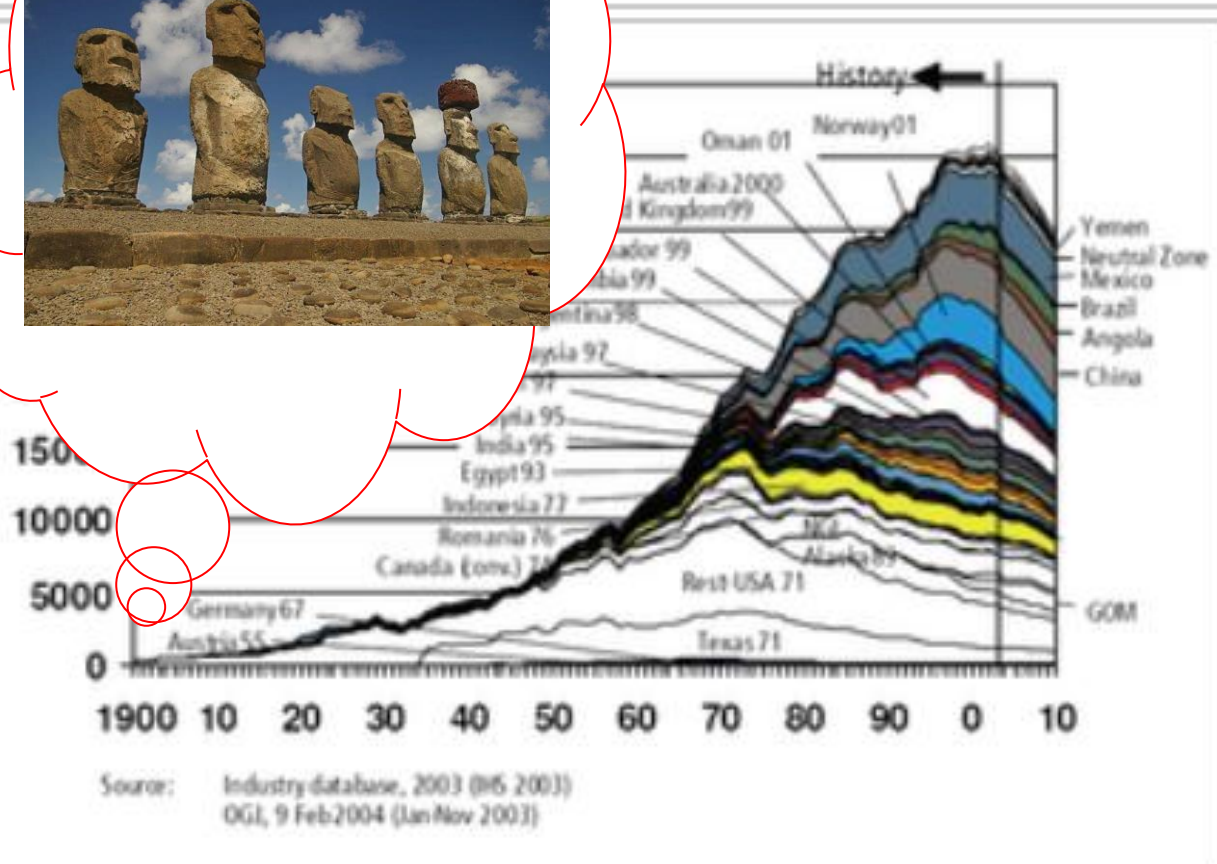

CO2 is a basic KPI to drive the improvement

Sustainable Mobility challenge : vision 2016

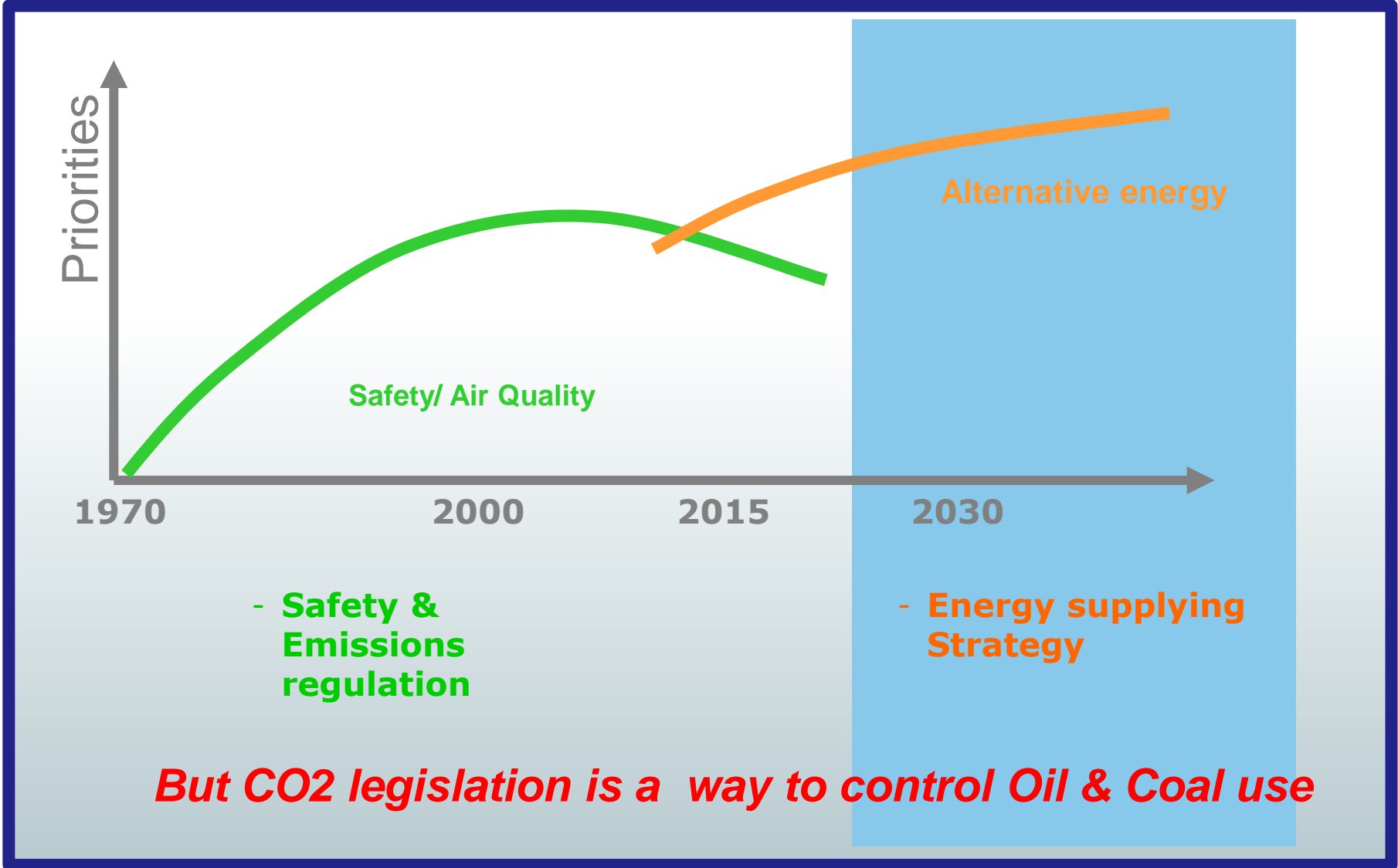

Hydrogen Energy Carrier

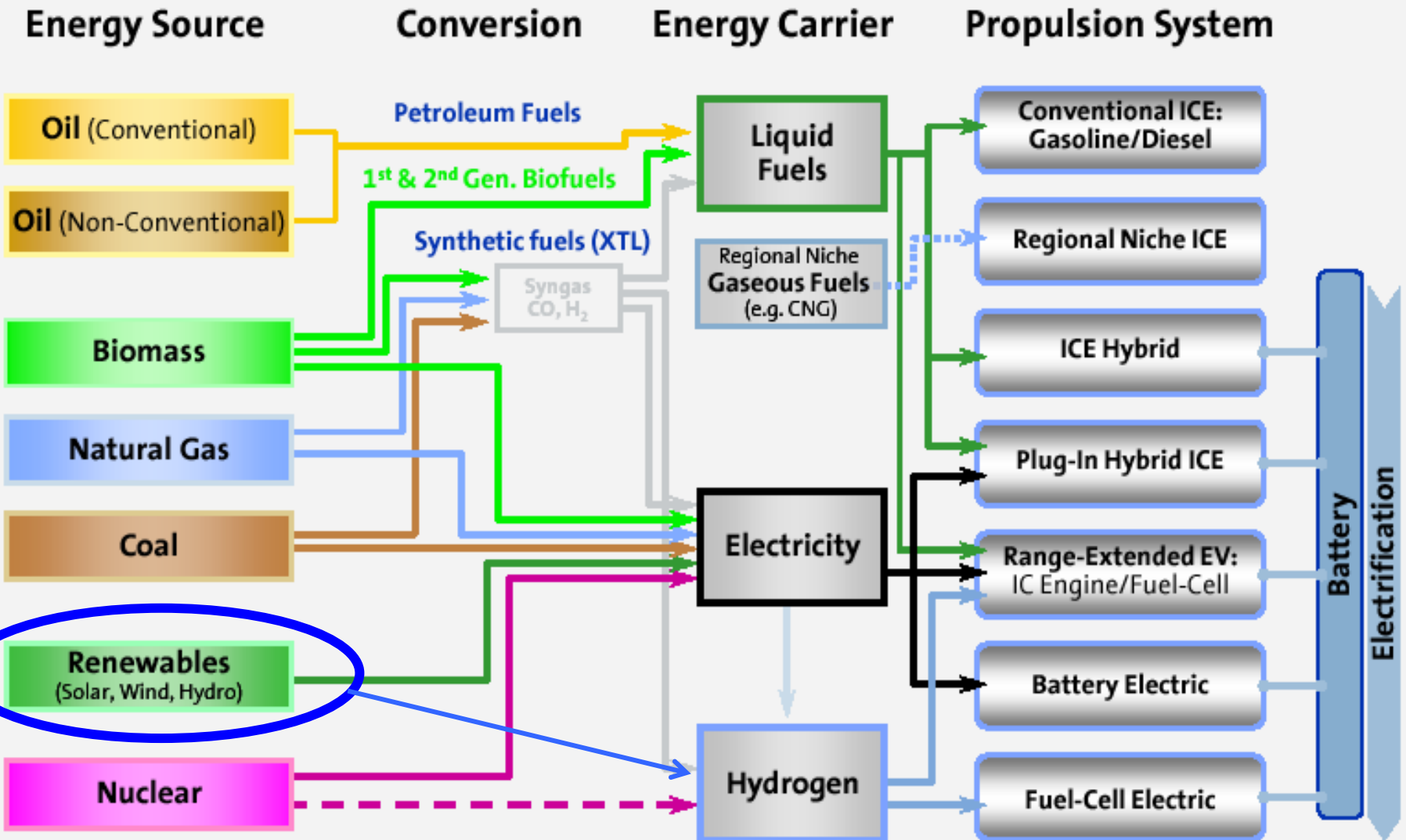

Hydrogen Energy Carrier

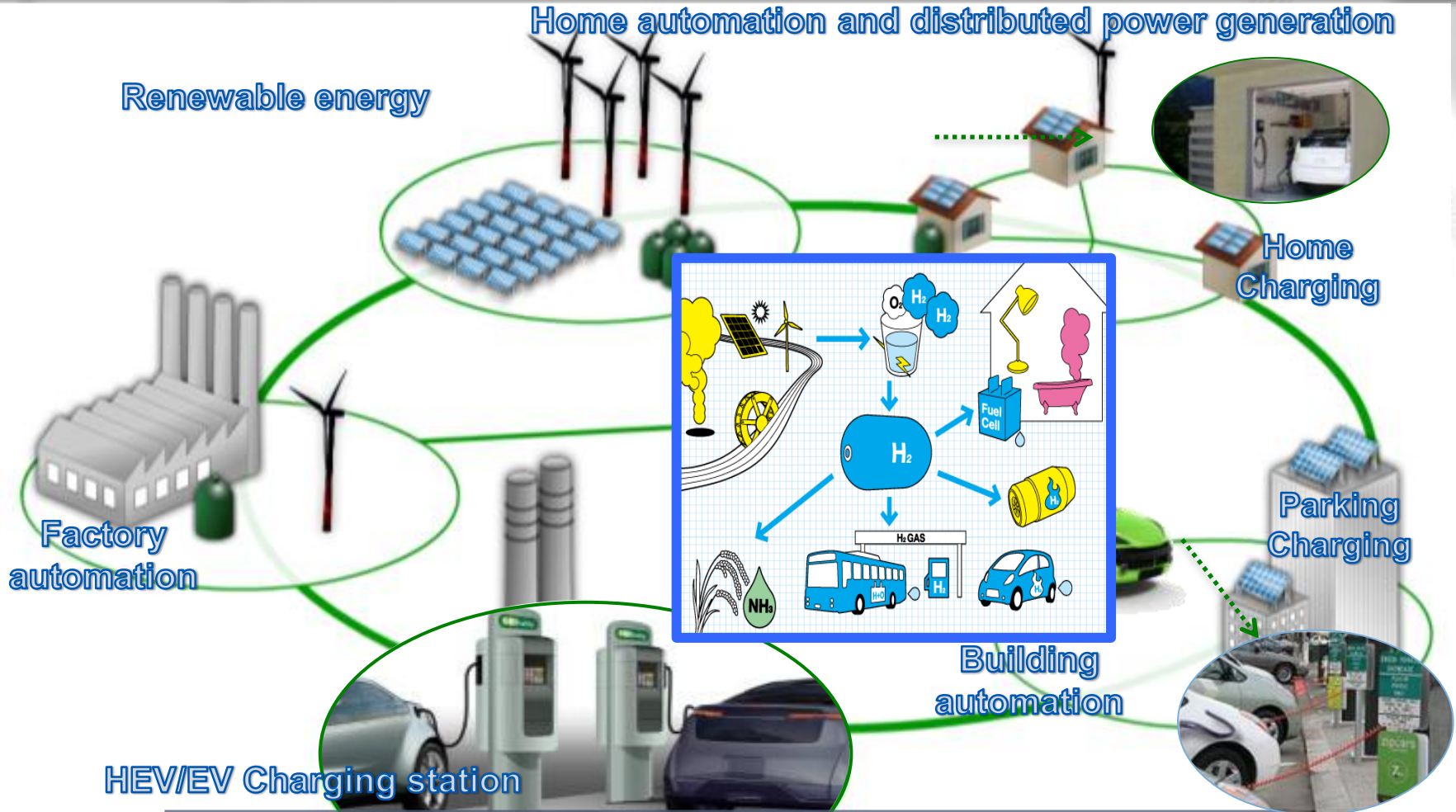

Hydrogen Energy Carrier

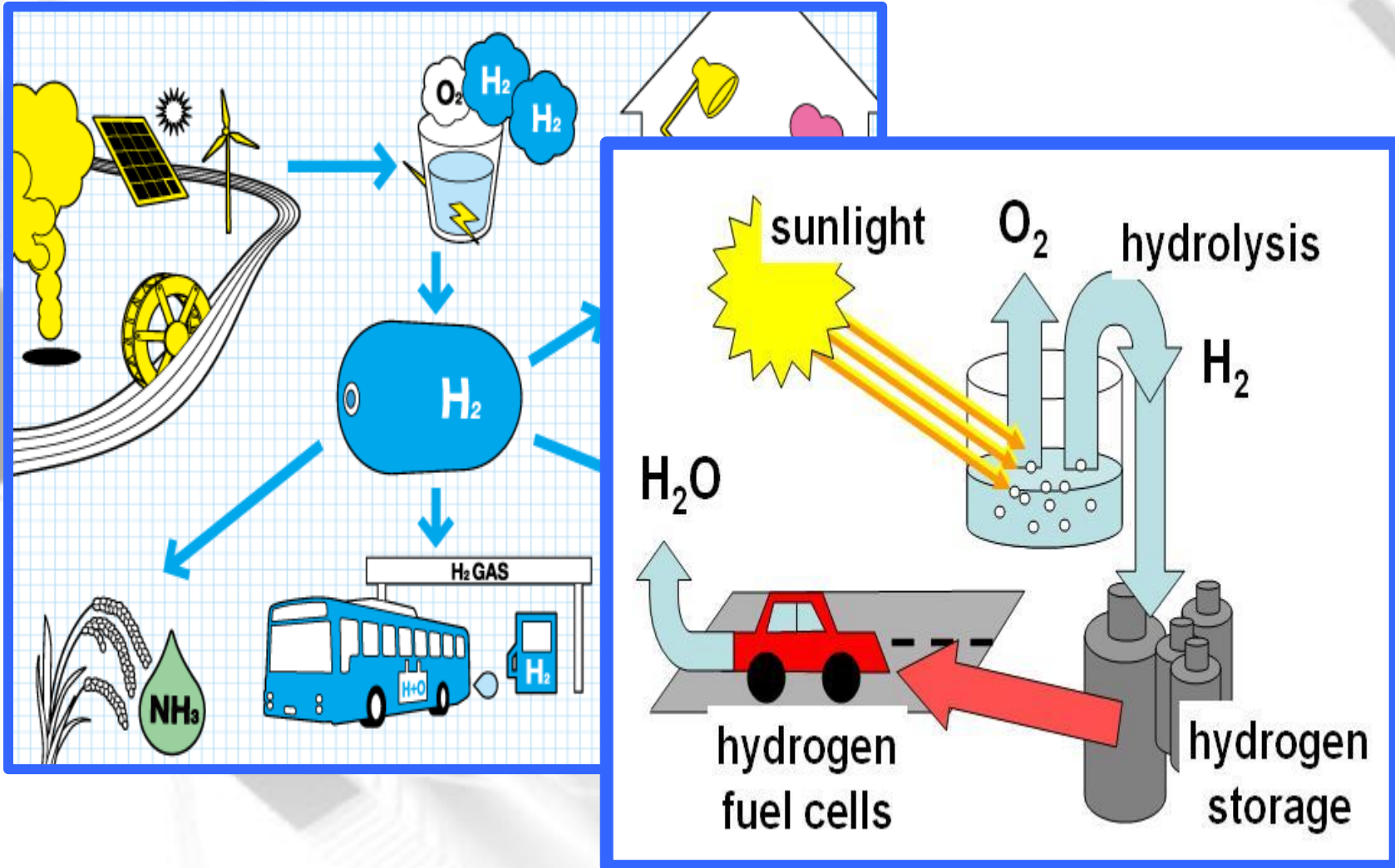

Well-to-Wheels Greenhouse Gases Emissions for Future Mid-Size Car

(Grams of CO₂-equivalent per mile)

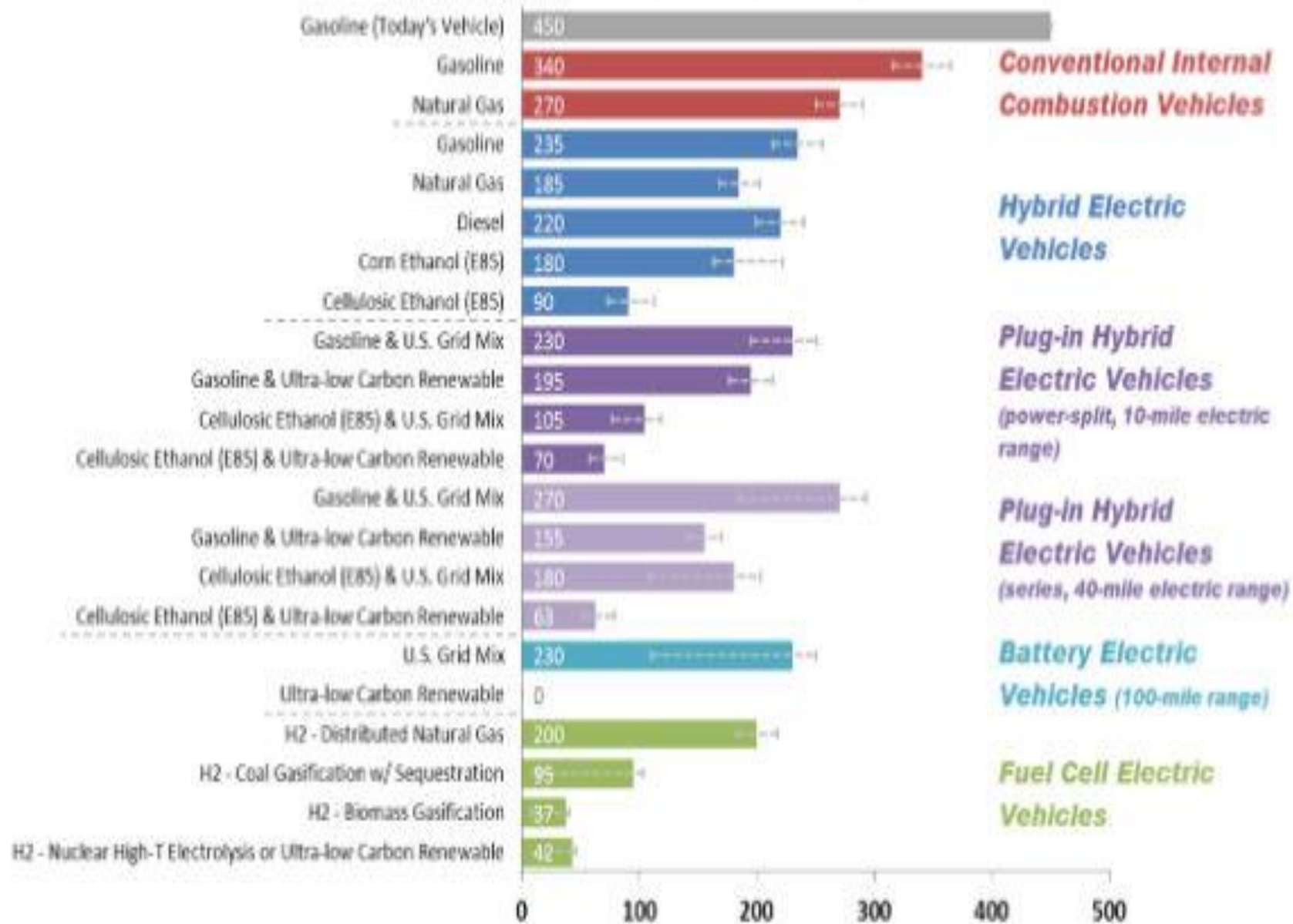

**Toyota Mirai ready to be in your garage : 66K€ price
(6.500.000¥ in Japan)**



Toyota Mirai ready to be in your garage

**MAGNETI
MARELLI**



Toyota Mirai ready to be in your garage

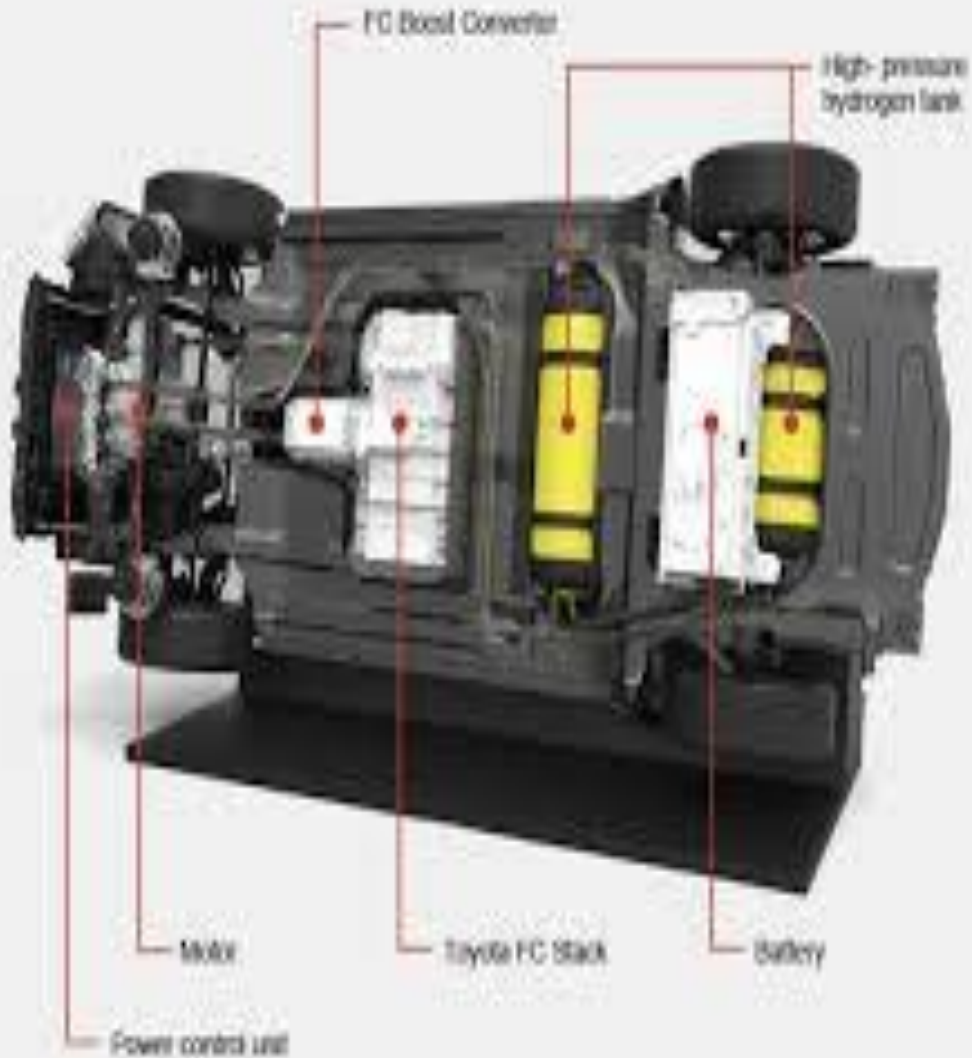

History: TIME TO GO IN MASS PRODUCTION WITH REVOLUTIONARY TECHNOLOGY



1st Vw Calif

1966



1st F1 MM

1984



Fiat Chroma MM

1989



Fiat Punto MM

1991



Euro 1

Electronic fuel injection cycle to mass production : 25 years



1st Toyota Prius

1995



1st F1 MM

2009



MB S Hybrid

2011

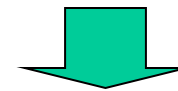

XXX xxx

2013

2020

US CAFÉ – EU CO₂

Hybrid Vehicle cycle to mass production : 25 years

EXPECTED TIME TO GO IN MASS PRODUCTION WITH HYDROGEN TECHNOLOGY



1st Toyota MIRAI



MB S Hydrogen



xxxx ??

Mass Production components

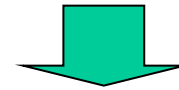

XXX xxx



Hydrogen Vehicle cycle to mass production : 25 years

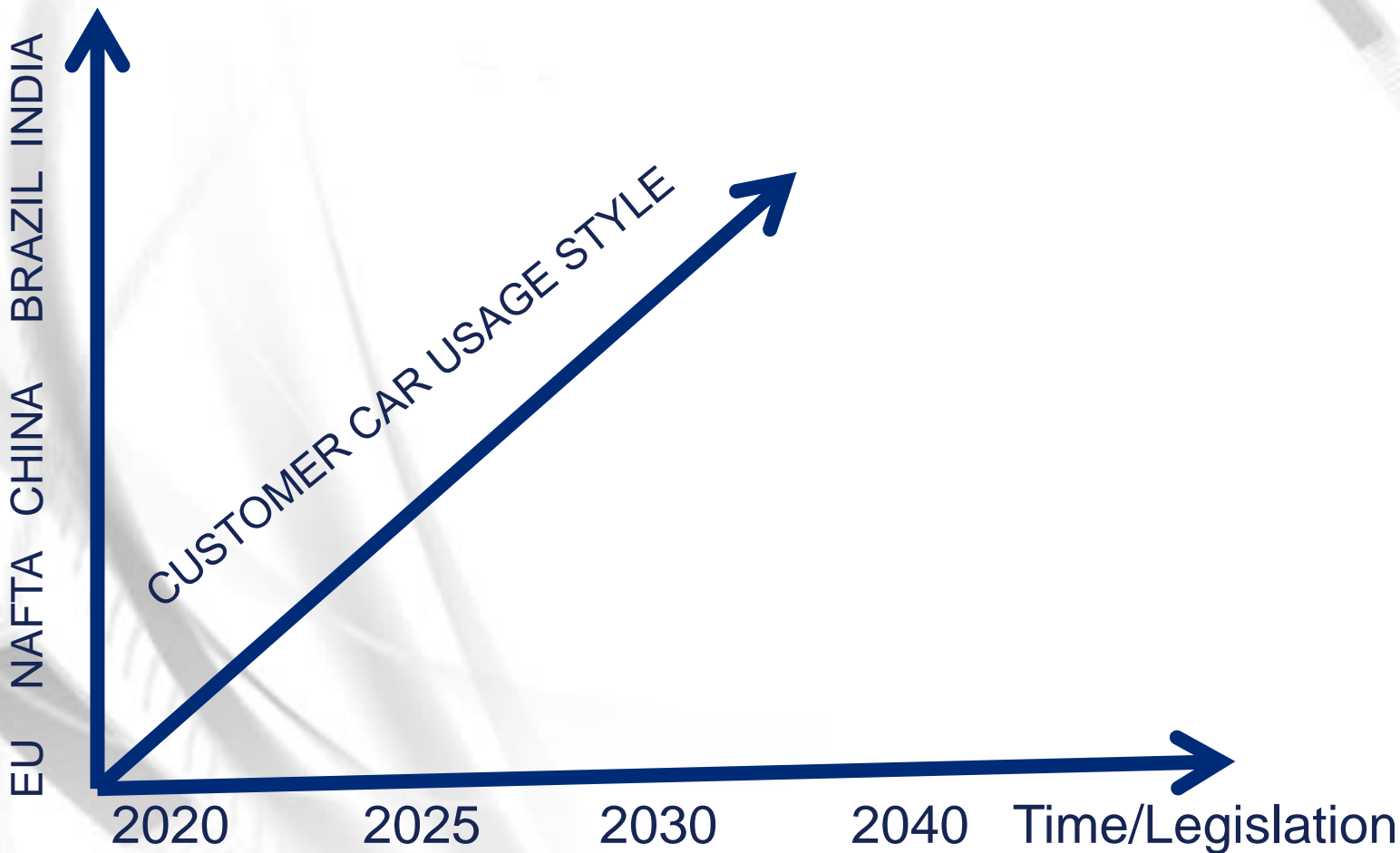

APPLICATION BASED DESIGNS

EXAMPLES OF POSSIBLE VEHICLE DESIGNS



SHORT-DISTANCE VEHICLE



MEDIUM-TO-LONG-DISTANCE VEHICLE



MULTI-PURPOSE VEHICLE

Primary uses	> Short trips within cities, suburbs or for last mile transportation to/from public transit such as the nearest subway station	> Medium-to-long-distance trips in suburbs and cities	> Personalized and/or leisure travel for multiple passengers
Primary focus	> Easy maneuverability and low cost	> Higher comfort for longer trips	> Personalized travel experience and comfort
Average trip distance	> Mostly under 10-15 miles	> Mostly over 10-15 miles	> Any range
Design	> Mini-vehicle	> Medium to large vehicle	> Medium to large vehicle
Capacity	> 1-2 passengers > Limited cargo space	> 4+ passengers > Large cargo space	> 1-4+ passengers > Limited/large cargo space
Ownership	> Shared mobility	> Shared mobility	> Personal ownership
Areas of use	> Cities and suburbs	> Cities and suburbs	> Cities, suburbs and rural
Important attributes	> Fuel efficiency > Low emissions > Low maintenance > Reliability	> Comfort > Fuel efficiency > Low emissions > Low maintenance > Reliability > Infotainment	> Individualization > Comfort > Online services > Infotainment > Fuel efficiency > Low emissions > Low maintenance

CUSTOMER CAR USAGE STYLE

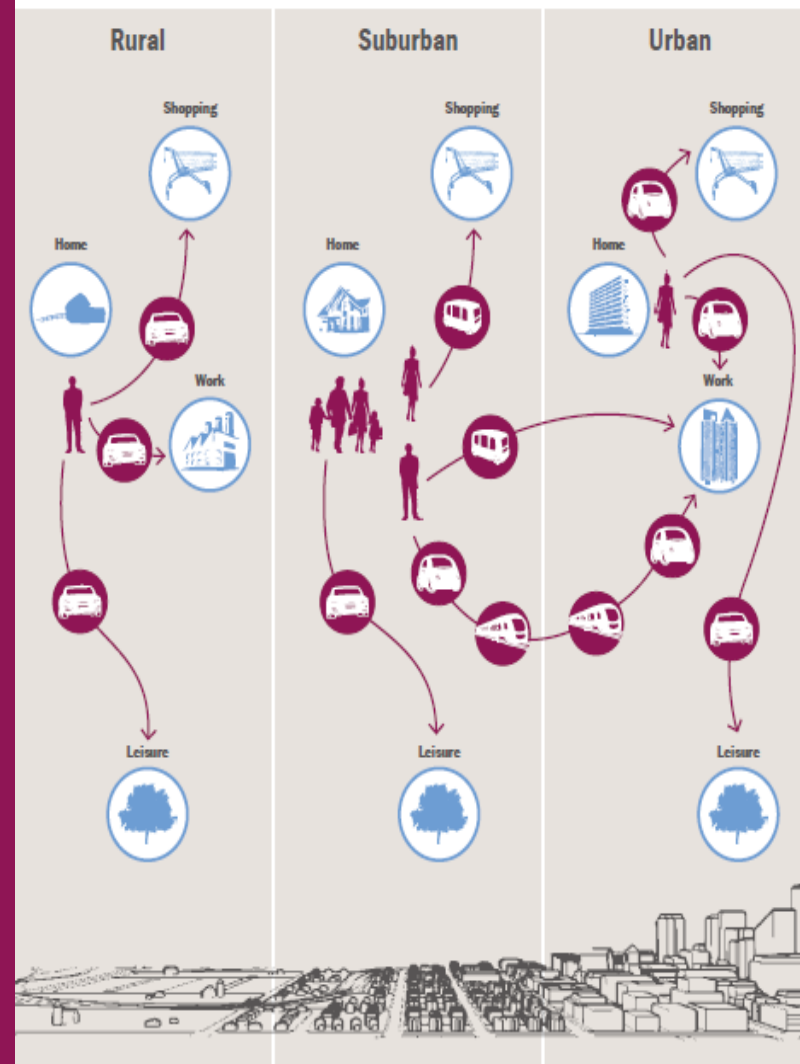

Changes in mobility behavior

New segments of specialized vehicles designed for very specific needs → optimal mobility solution

Exhibit 3

Today consumers use their vehicles for all purposes; in the future, they will choose an optimal mobility solution for each specific purpose

Today:
One vehicle for every trip purpose

Avg. share of annual driving time



2030:
A solution for each specific purpose¹



¹ Only showing automobile based mobility, alternative options like walking, biking, and public transportation are also included in optimal mobility solutions
SOURCE: McKinsey

AUTOMOTIVE AND MAGNETI MARELLI FUTURE CHALLENGES



ENVIRONMENTAL
SUSTAINABILITY



CONNECTIVITY



SAFETY



AFFORDABLE
MOBILITY



INTEGRATION



NEW HMI

EXTENDED CONNECTIVITY

AUTONOMOUS DRIVING

ELECTRONICS EVOLUTION
(nuove topologie e architetture sw)

Autonomous Drive

The unique way to make a quantum lap in safety & consumption



Over 90% of accidents are due to driver distraction or insufficient driving skills.



The driving approach "passionate" is not the best way to reduce fuel consumption.



To optimize the mobility system driver is required to be **very rational**, able to manage in advance the **driving strategies**.



It's best to use a **robot** !

Autonomous Vehicle Sales by Region, World Markets: 2015-2035

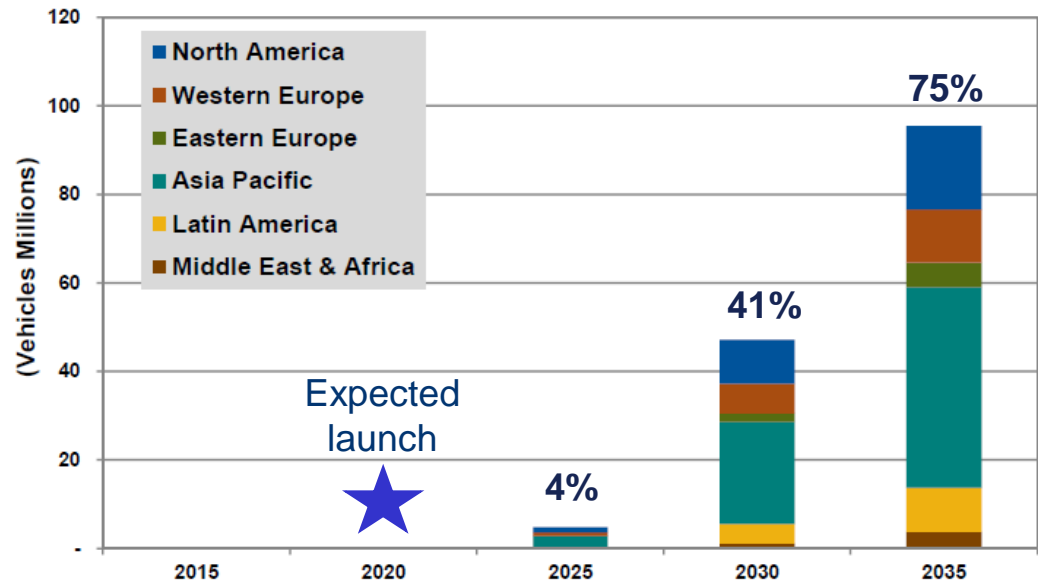

(Source: Navigant Research)

- **Perception technology** is growing rapidly; data fusion is the key word
- **V2X connectivity** will become dominant for many autonomous functions
- **The cost of the sensors** will decrease with the increase of the volumes
- **There is no legislation**, "each car must have a driver" (Vienna Convention), is a major obstacle
- **Liability** issues arise: « The OEM will sell both the vehicle and the driver »

VEHICLES AUTONOMOUS

An opportunity for the "virtuous circle"



The Autonomous Vehicle is driven by **Security**, but it can give more opportunities addressed to both the **Environmental** and **Social Sustainability**

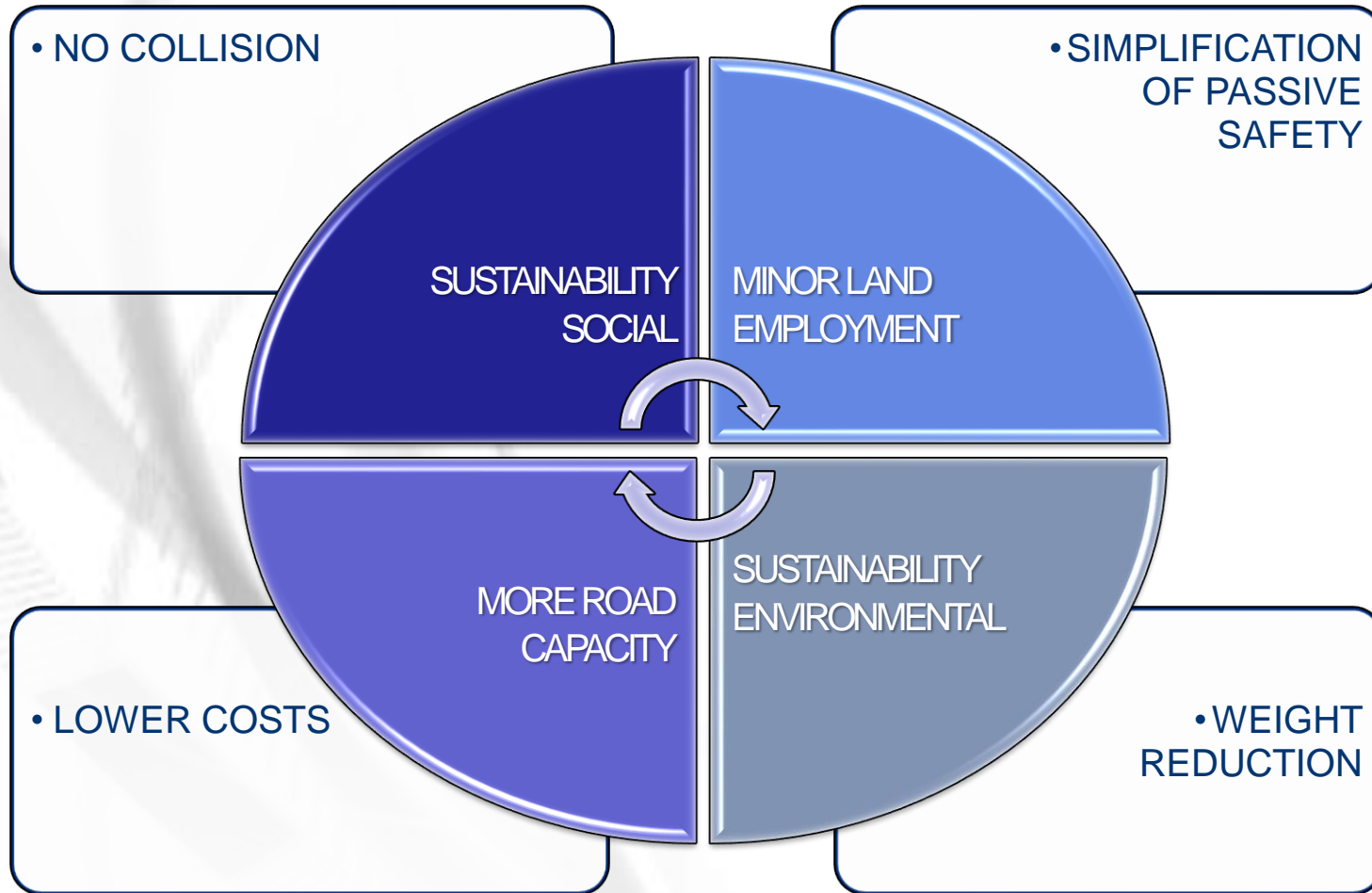

• Thank You